

WARRANTY

Limited Warranty

- This warranty covers defects in materials and workmanship of products manufactured, sold or certified by Plantronics which were purchased and used in the United States.
- This warranty lasts for one year from the date of purchase of the products.
- This warranty extends to you only if you are the end user with the original purchase receipt.
- We will, at our option, repair or replace the products that do not conform to the warranty. We may use functionally equivalent reconditioned/refurbished/remanufactured/pre-owned or new products or parts.
- To obtain service in the U.S., contact Plantronics at (800) 544-4660 ext. 5538.
- THIS IS PLANTRONICS' COMPLETE WARRANTY FOR THE PRODUCTS.
- This warranty gives you specific legal rights, and you may also have other rights that vary from state to state. Please contact your dealer or our service center for the full details of our limited warranty, including items not covered by this limited warranty.



PLANTRONICS
SOUND INNOVATION™

→ ● ● ● → USER GUIDE_

MAINTENANCE

1. Replace voice tube every 6-9 months.
2. Unplug the unit from the telephone and the AC charger from the power source before cleaning.
3. Clean the equipment with a damp (not wet) cloth.
4. Do not use solvents or other cleaning agents.

TECHNICAL SUPPORT

The Plantronics Technical Assistance Center is ready to assist you! Dial (800) 544-4660 ext. 5538, or visit the support section of our website at www.plantronics.com/support.



Plantronics Inc.

345 Encinal Street
Santa Cruz, CA 95060 USA
Tel: (800) 544-4660

www.plantronics.com

© 2006 Plantronics, Inc. All rights reserved. Plantronics, the logo design, IntelliStand, Plantronics Sound Innovation, and the voice tube clear color trade dress are trademarks or registered trademarks of Plantronics, Inc. All other trademarks are the property of their respective owners.

Patents U.S. 5,210,791; 6,735,453; 6,923,688; D469,756; Australia 147229; 303053; EM 293964-0003; France 651,857-651,865; Germany 40108524.4; GB Regd.Des.No. 2104923 and Patents Pending.

Printed in China.

72535-01 [01.06]

CS70

WIRELESS OFFICE HEADSET SYSTEM



TABLE OF CONTENTS

Package Contents	3
Features	4
Setup	6
Setup – Handset Lifter (Optional)	8
Charging	9
Positioning	9
Adjusting Fit	10
Multi-shift Pairing	11
Making/Answering/Ending Calls	12
Checking Compatibility	14
Volume	15
Headset Controls	17
Base Indicator Lights	18
Voice Tube Replacement	18
Troubleshooting	19
Subscription	21
System Reset	21
Battery Replacement	21
Additional Parts (if required)	22
Regulatory Notices	23

REGISTER YOUR PRODUCT ONLINE

Visit www.plantronics.com/productregistration to register your product online so we can provide you with the best possible service and technical support.

PACKAGE CONTENTS

Headset

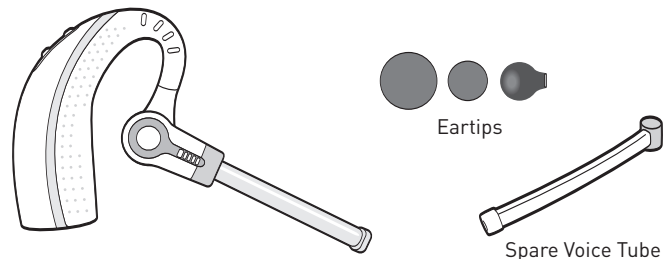

Base

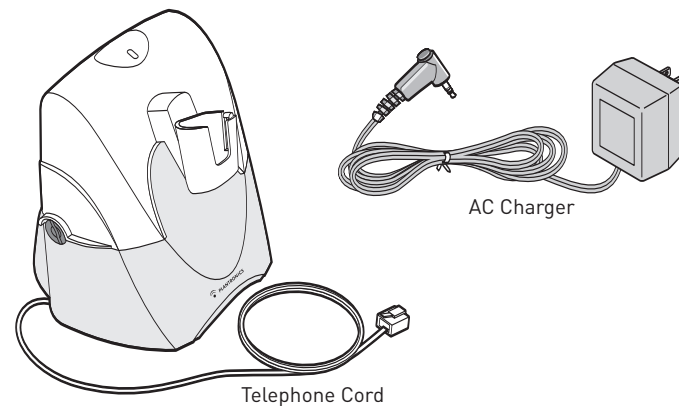

Handset Lifter (Optional)

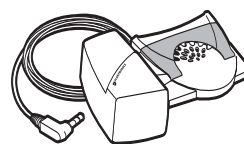

Handset Lifter

Additional parts (if required). Details on page 22.

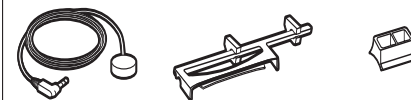

Ringer Microphone

Extender Arm with Stabilizers

For Nortel i2004 phones only

Base - Top View

Front:

- Indicator Lights
 - Talking (Green)
 - Power (Red)
 - Charging (Amber)

- Charging Cradle
- Telephone Configuration Dial

Rear:

- Speaking Volume Minor Adjust
- IntelliStand™ On/Off Switch (to automate call control button)
- Listening Volume Major Adjust
- Telephone Cord

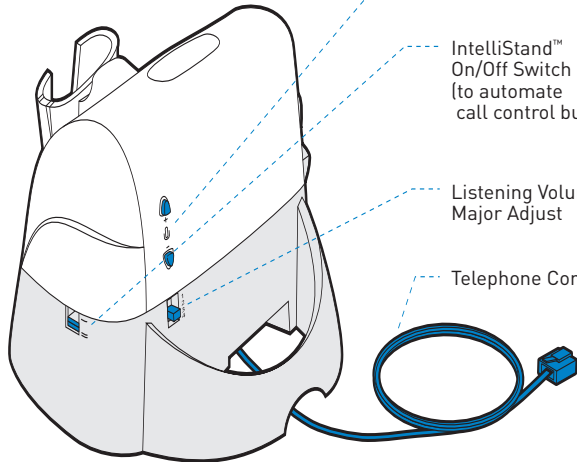
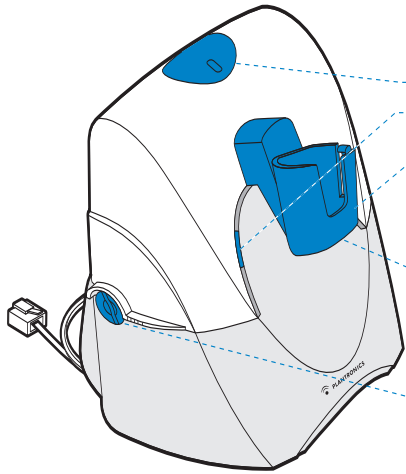

Base - Bottom View

- Telephone Handset Jack
- Handset Lifter Jack
- AC Charging Jack
- Telephone Cord Jack
- Speaking Volume Major Adjust

Headset

- Listening Volume/Mute
- Call Control Button
- Talk Indicator Light
- Voice Tube

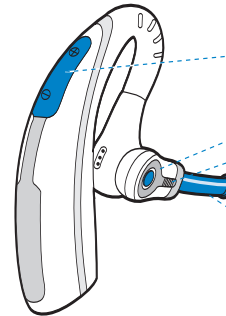

Handset Lifter

- Handset Lifter Arm
- Power Cord
- Ringer Microphone Jack (remove cover)
- Height Switch
- Accessory Jack

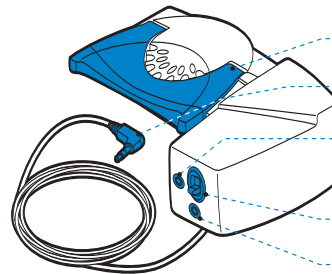

SETUP

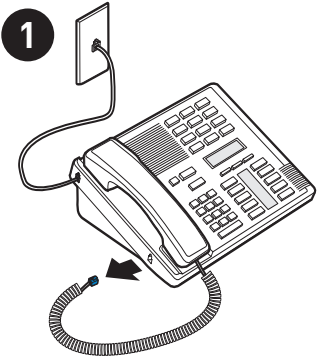

Unplug the handset cord from phone.

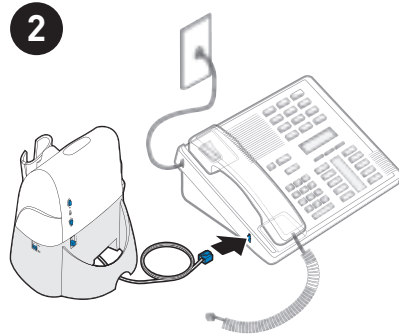

Plug the phone cord that is connected to the CS70 base into the handset jack on the phone.
CAUTION: Your phone may have two similar jacks. Put the cord only in the jack from which the handset came.

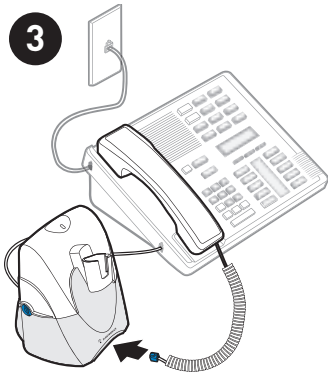

Plug the handset cord into the handset jack in the bottom of the base.

See step 3A for detailed location.

NOTE: The access to the handset jack is fairly small. If you have large hands you may want to ask someone with smaller fingers to do this step.

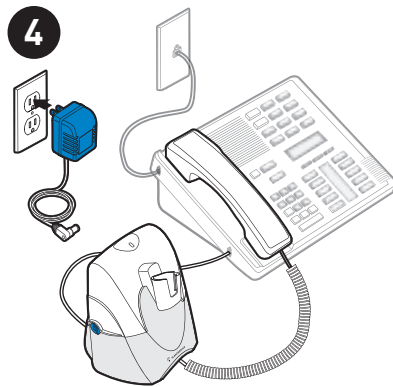

Plug the AC charger into an outlet and into the base's AC charging jack.

See step 4A for detailed location.

SETUP

Base - Bottom View

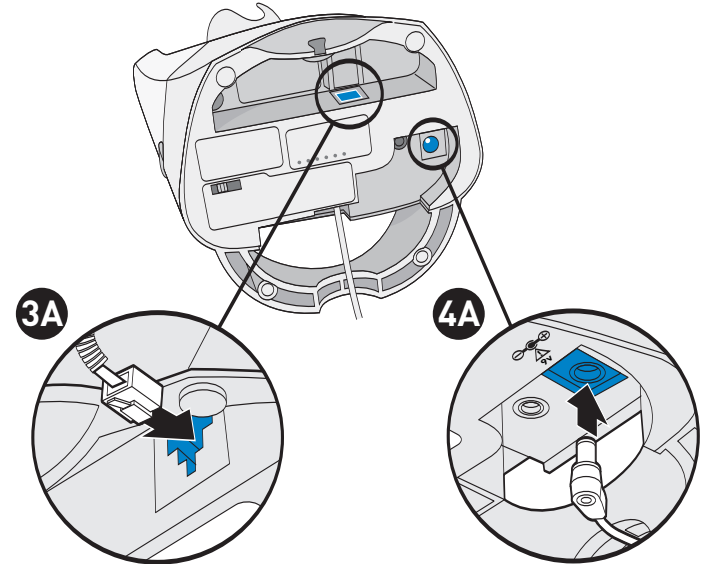

Plug the handset cord into the handset jack in the base.
Push in until it clicks.

Plug the AC charger into the base's AC charging jack.
Push in firmly.

Complete

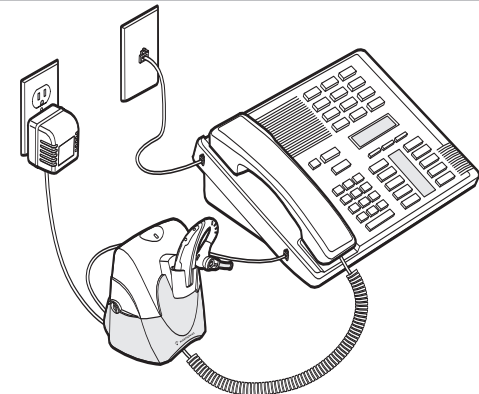

SETUP—HANDSET LIFTER (Optional)

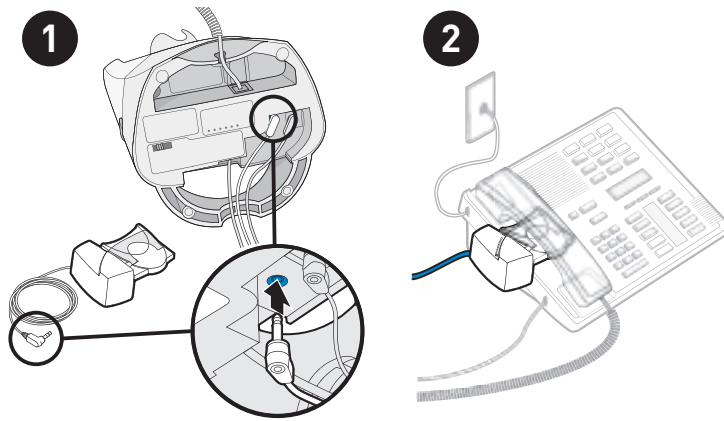

1. Plug handset lifter power cord into handset lifter jack on base. Push firmly into base.
2. Position handset lifter under the handset on your phone. Verify that the lifter is located on top of the telephone speaker. If not, you will need to attach the ringer microphone as described on page 22.

NOTE: Remove only a tiny piece of mounting tape backing to temporarily stick lifter into position; you may need to move it later.

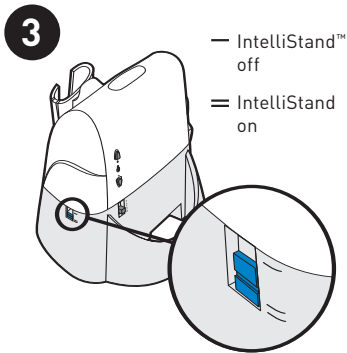

— IntelliStand™ off
 = IntelliStand on

Set the IntelliStand switch to IntelliStand off (—) if you want to control the handset lifter with the call control button on your headset.

Set the IntelliStand switch to IntelliStand on (=) if you want the handset to automatically pick up when you take the headset off the charging cradle.

CHARGING



1. Slide headset into charging cradle so that microphone boom is on the right.
2. Gently press down on the headset to ensure that headset is in correct position. Amber charge indicator light on base will flash while charging and will change to solid amber when fully charged.

- 20 minutes = minimum charge to continue setup
- 3 hours = full charge



POSITIONING

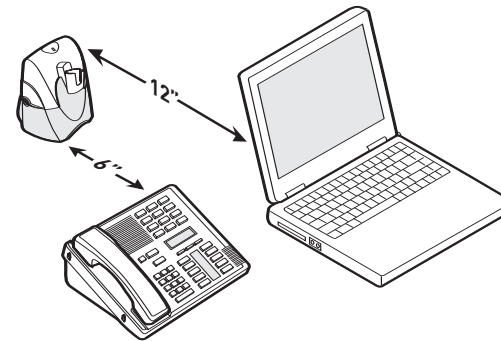

The **minimum** recommended separation distance is shown above.

IMPORTANT: Incorrect positioning can cause noise and interference problems.

ADJUSTING FIT

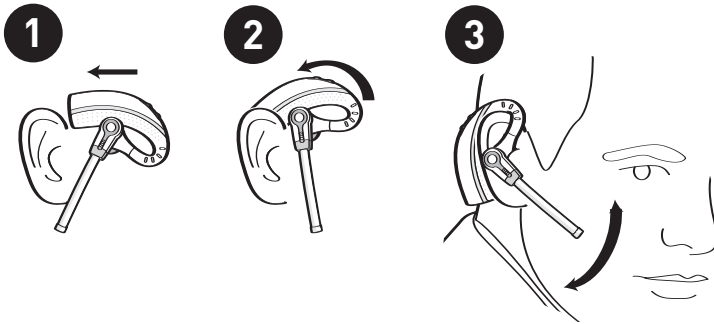

1. Slide the headset over and behind your ear.
2. Rotate and press gently towards your ear for a snug fit.
3. Rotate voice tube microphone until it is pointed towards your chin.

MULTI-SHIFT PAIRING

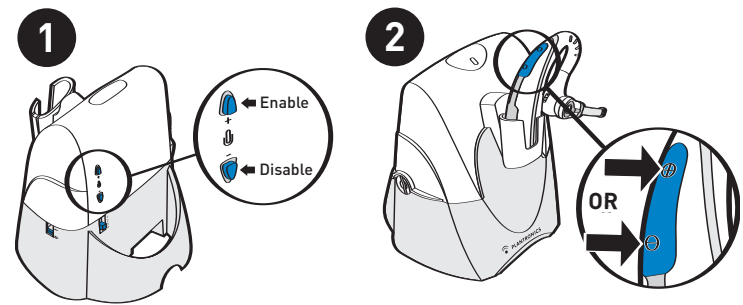

1. To pair another headset to the same base, you must first enable the multi-shift pairing feature. Long press (5 sec.) the speaking volume minor adjust **up** button on back of base until the power indicator light flashes.
2. Place a charged headset in charging cradle and red indicator light on base will flash for 2 seconds if the multi-shift pairing feature is enabled. Within 10 seconds of doing so, press either the "+" or "-" listening volume button for 3 seconds until the headset talk indicator lights to indicate pairing mode, and goes out after successful pairing. Repeat steps 1 and 2 if headset and base do not link when call control button is pressed.

NOTE: Only the last paired headset will work with the base. You must NOT be in talk mode (i.e. not on a call) when enabling or disabling this feature.

To disable the multi-shift pairing feature, long press (5 sec.) the speaking volume minor adjust **down** button until the power indicator light flashes.

Without Handset Lifter

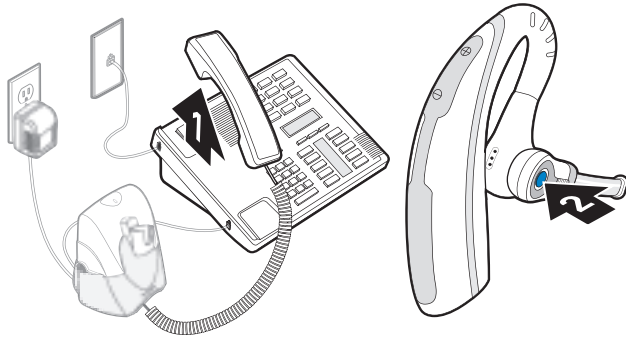

To make a call:

1. Take your handset off-hook. Dial tone should sound through handset (if not, check compatibility—see page 14).
2. Press the call control button on the headset. The talk indicator lights on both the base and the headset should go on, indicating a successful link. Dial tone should sound through headset. Dial using the telephone keypad.

To answer a call:

1. Take the handset off-hook.
2. Press the call control button on the headset to answer a call.

To end a call, press the call control button on the headset, then hang up the handset.

NOTE: If either you or the recipient have trouble hearing, please check compatibility (page 14).

With Handset Lifter (Optional)

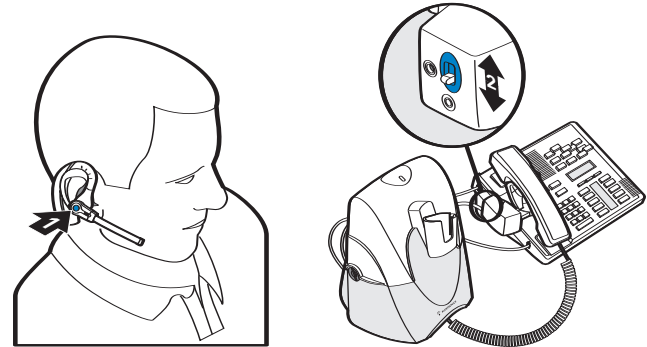

To first test proper set up of the handset lifter:

1. Press the call control button on headset to activate handset lifter and lift handset from phone. Dial tone should sound if the handset is raised high enough.
2. If no dial tone, adjust handset lifter height switch or reposition lifter under handset. If you still do not hear a dial tone, you may need to insert extender arm (see page 22) or check compatibility (page 14).

Use mounting tape to secure handset lifter in position.

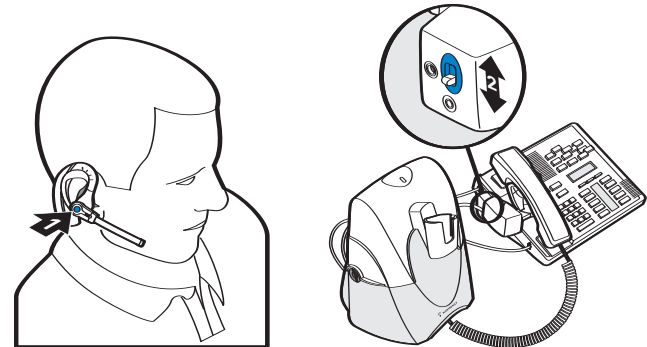

To make/answer a call:

1. Press the call control button to raise the handset lifter.
2. Use the telephone keypad to dial the number.

To end a call:

Press the call control button to lower the handset lifter. (Phone will hang up).

NOTE: If either you or the recipient have trouble hearing, please check compatibility (page 14).

CHECKING COMPATIBILITY

NOTE: The compatibility setting of "1" is set at the factory to work with most phones. However, if you do not hear a dial tone, if either you or the recipient is having trouble hearing, or if you experience buzzing/hissing, please follow the directions below.

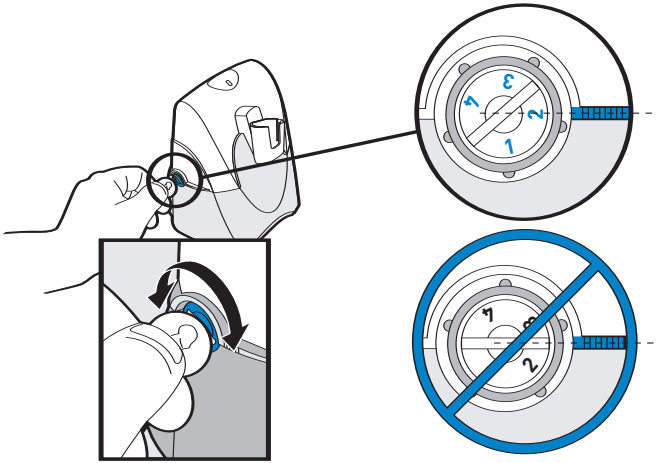

If you cannot hear a dial tone through your headset, use a coin or small screwdriver to turn the telephone configuration dial until you can. **Make sure that a number is aligned with the position indicator.**

Place a call to someone you know. While speaking, turn the configuration dial through the four positions. Select the position that provides the best sound quality for both you and the recipient.

LISTENING VOLUME

NOTE: Be sure to set your telephone's volume at the mid range before adjusting the CS70 volume.

Minor Adjust

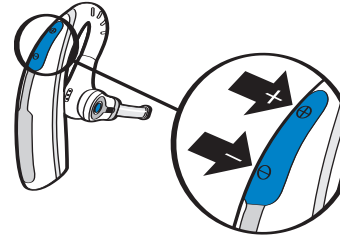

Push on the "+" and "-" buttons to adjust listening volume in minor incremental adjustments.

NOTE: You must be in talk mode (i.e. on a call) to adjust.

Major Adjust

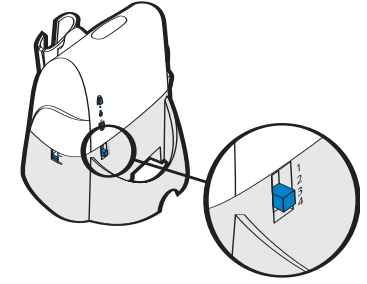

Use listening volume major adjust control on the back of the base for large incremental adjustments.

*NOTE: 1 is the loudest setting.
4 is the lowest setting.*

SPEAKING VOLUME

Minor Adjust

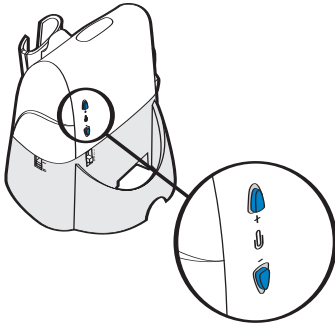

Use the speaking volume minor adjust control on the back of the base for minor incremental adjustments.

NOTE: You must be in talk mode (i.e. on a call) to adjust.

Major Adjust

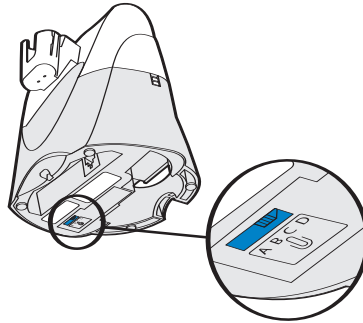

Use the speaking volume major adjust control on the bottom of the base for large incremental adjustments.

*NOTE: A is the lowest setting.
B is the most common setting.
D is the loudest setting.*

Headset Mute

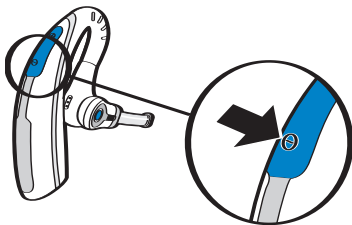

To mute headset, long press the volume down button (3 seconds). Press again to unmute.

Talk indicator light on base will flash while muted.

You will hear 3 rapid beeps every 30 seconds to indicate that mute is on.

HEADSET CONTROLS

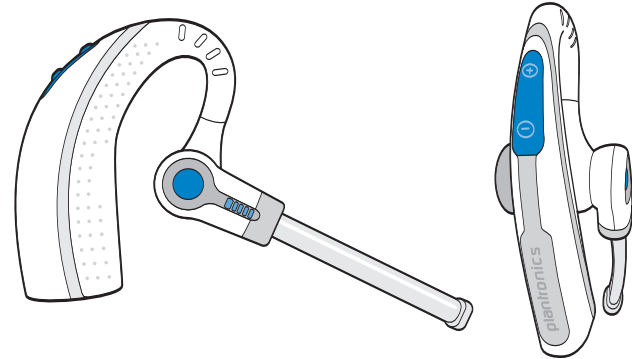

Feature	Action	Tone
Listening volume minor adjust	Press + to increase or - to decrease	Ascending/descending tones, 2 tones at limit
Mute	Long press - key (3 seconds)	3 mid tones = Mute 3 low tones = Unmute <i>NOTE: Tones repeat every 30 seconds when muted.</i>
Answering/ending calls	Short press call control button	Mid tone
Low battery warning	Replace headset in charging cradle	1 tone every 10 seconds
N/A Out of range warning — when on active call	Move closer to base	2 tones
N/A Incoming call notification*	Press call control button to answer call	3 repetitive tones

* Only works when using optional Handset Lifter.

BASE INDICATOR LIGHTS

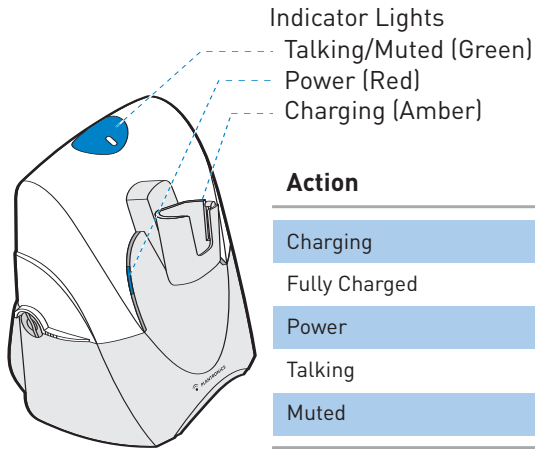

Action	Light
Charging	Flashes amber
Fully Charged	Solid amber
Power	Solid red
Talking	Solid green
Muted	Flashes green

VOICE TUBE REPLACEMENT

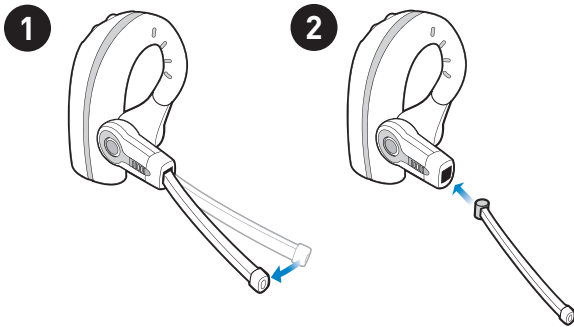

To replace voice tube:

1. Slide old voice tube out.
2. Slide in spare voice tube.

TROUBLESHOOTING

Problem	Solution
I plugged everything in but the lights won't come on.	<ul style="list-style-type: none"> • Check that the AC charger jack is connected to the base unit. • Check that the AC charger is securely connected to a working wall outlet. • Check that the AC charger is the model supplied by Plantronics.
My headset does not work with the base unit.	<ul style="list-style-type: none"> • Check that the phone is connected to the base unit's phone cord jack and it is pushed in firmly. • Check that the phone handset is connected to the base's phone handset jack and it is pushed in firmly. • Headset may be out of range of the base. Move closer to base unit until headset is within range. Range varies with office environment. • Headset battery is dead. Recharge the battery by placing the headset in the headset charging cradle or by using the AC charger supplied. See page 9. • Listening volume too low. Press the volume up button on the headset. If the volume is still too low, select another listening volume major adjust switch setting. See page 15. • Incorrect configuration dial setting for your phone. Try other phone configuration dial settings on the base unit. Ensure the selected number is in line with the position indicator. See page 14. • You may have to resubscribe your headset with the base. See page 11.
Callers cannot hear me.	<ul style="list-style-type: none"> • Headset is muted. Long press (3 sec.) the volume down button on headset to unmute the microphone. See page 16. • Improper positioning of voice tube. Try various other positions. • Voice tube may be clogged. Remove voice tube and test to see if callers can hear you without it. If they can, then replace the clogged voice tube. See page 18. • Speaking volume is too low. Increase the speaking volume by adjusting the speaking volume minor adjust buttons on the base unit as described on page 16. If the volume is still too low, select another speaking volume major adjust setting as described on page 16. • Incorrect configuration dial setting for your phone. Try other phone configuration dial settings on the base unit. Ensure the selected number is in line with the position indicator. See page 14.
I can hear a dial tone in more than one configuration position.	<p>Phone will work in more than one configuration dial position. Use the position that sounds best to you and the person you call.</p>
I cannot hear a dial tone in any configuration position.	<ul style="list-style-type: none"> • Check that the phone is connected to the base's phone cord jack. See page 6. • Check that the phone handset is connected to the base's phone handset jack. See page 6.
I cannot hear caller/dial tone.	<ul style="list-style-type: none"> • Check that all cords and jacks are connected correctly. • Check that the base has power (red indicator light) and the headset battery is fully charged. • Try other phone configuration dial settings on the base unit. Ensure the selected number is in line with the position indicator. See page 14. • Ensure you are in headset mode. Press the call control button to select correct mode. The talk indicator light on the base is green.

TROUBLESHOOTING

Problem	Solution
Sound in headset is distorted/hear echo in headset.	<ul style="list-style-type: none"> Reduce speaking volume by changing the speaking volume major adjust switch setting. See page 16. Point microphone towards your chin. Listening volume too high on phone. If your phone has a headset volume control, lower this until the distortion disappears. If the distortion is still present, lower the listening volume adjust button on the headset. If the distortion persists, select another listening volume major adjust switch setting. See page 15. Base is too close to computer or phone. See page 9 for proper positioning. System needs to be reset. Perform system reset as described on page 21.
I can hear too much background conversation, noise or sidetone.	Speaking volume is too high. Lower the speaking volume by adjusting the speaking volume minor adjust buttons on the base. If the volume is still too high, select another speaking volume major adjust setting. See page 16.
People I talk to can hear a buzz in the background.	<ul style="list-style-type: none"> Move the CS70 base further away from your phone. AC charger is plugged into a power strip. Plug the AC charger into the wall directly. Picking up another radio frequency. Call the Plantronics Technical Assistance Center for an RF filter.
Battery talk time performance is significantly degraded even after a full recharge.	Battery is going bad. Replace the battery with a new battery pack. See page 21.
The call is dropped. (Talk indicator on the headset and base will not be illuminated.)	Headset lost subscription. Try to reset the system. See page 21. If this does not work, try the resubscription procedure on page 11.
I hear static that does not allow me to communicate.	<ul style="list-style-type: none"> Link to headset is lost. Try to reestablish a link by pressing the headset talk button. Unplug the AC charger from the base for 5 seconds, then plug back in. Reset the whole system as described on page 21.
I hear beeps in the headset.	<ul style="list-style-type: none"> One beep every 10 seconds is caused by a low battery warning. Recharge battery by returning it to the base charge cradle for one to three hours until charge light stays lit or quits blinking. Two beeps is an out of range warning. Move closer to the base. Three rapid beeps every 30 seconds indicates your mute is on. Press the mute button once to turn mute off. When an optional lifter is connected, three repetitive beeps indicate a call is coming into the headset. Press the call control button on the headset to answer the call.
Handset lifter is installed but does not lift handset.	Be sure the handset lifter power cord is firmly pushed into the handset lifter jack on the base.
My handset lifter operates every time I remove or replace my headset in the base unit.	IntelliStand is enabled. To disable the handset lifter, move the IntelliStand switch to position —.

SUBSCRIPTION

The headset and base unit are supplied subscribed to each other. However, if you wish to use a replacement headset with the base unit, then the units must be re-subscribed. To do so, please follow the instructions on page 11 for Multi-Shift Pairing.

SYSTEM RESET

To recover from some fault conditions (refer to the Troubleshooting Section), you may need to perform a system reset. To perform the system reset, follow this procedure:

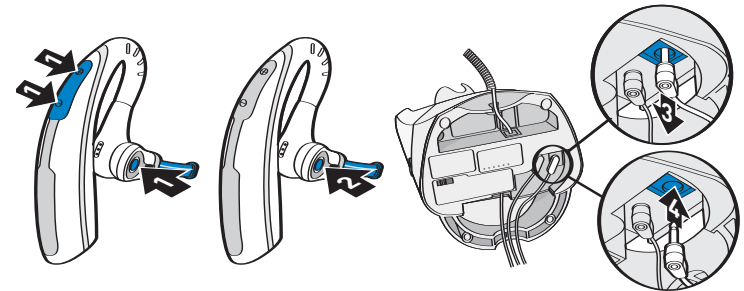

1. Simultaneously press the call control button and both the "+" and "-" volume buttons for 5 seconds. When the talk indicator light on the headset blinks, release all buttons.
2. Press the call control button again. The talk indicator light will again blink briefly to indicate the headset is back to normal operation mode.

3. Disconnect the AC charger from the AC charging jack for 5 seconds.
4. Reconnect.

The system reset operation is complete.

BATTERY REPLACEMENT

The custom battery supplied should last 2–3 years. When talk time decreases significantly, you should replace the battery. Call Plantronics at (800) 544-4660 ext. 5538 for information on sending back to factory to install new battery.

Extender Arm

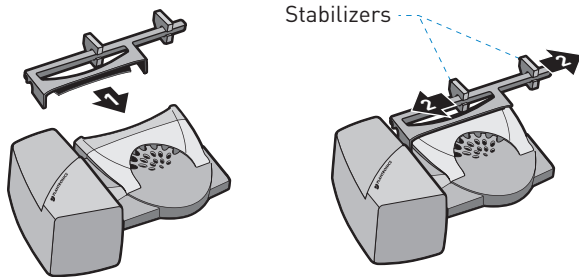

Use extender arm when the handset lifter needs additional stability lifting and returning to cradle.

1. Slide extender arm onto lifter.
2. Stabilizers can be shifted left and right. Position stabilizers on outsides of handset to gently grip the phone.

Ringer Microphone

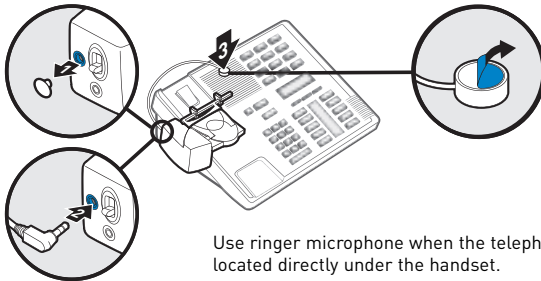

Use ringer microphone when the telephone speaker is not located directly under the handset.

1. Remove cover from ringer microphone jack on back of lifter.
2. Connect ringer microphone plug.
3. Place ringer microphone over phone speaker. Remove adhesive tape and attach.

For Nortel i2004 phones only

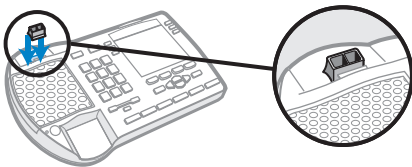

FCC Requirements

This device complies with Part 15 of the FCC Rules. Operation is subject to the following two conditions:

1. This device may not cause harmful interference, and
2. This device must accept any interference received, including interference that may cause undesired operation.

This equipment has been tested and found to comply with the limits for a Class B digital device, pursuant to Part 15 of the FCC Rules. These limits are designed to provide reasonable protection against harmful interference in a residential installation. This equipment generates, uses, and can radiate radio frequency energy and, if not installed and used in accordance with the instructions, may cause harmful interference to radio communications. However, there is no guarantee that interference will not occur in a particular installation. If this equipment does cause harmful interference to radio or television reception which can be determined by turning the radio or television off and on, the user is encouraged to try to correct interference by one or more of the following measures:

1. Reorient or relocate the receiving antenna.
2. Increase the separation between the equipment and receiver.
3. Connect the equipment into an outlet on another circuit.
4. Consult the dealer or an experienced radio/TV technician for help.

FCC REGISTRATION INFORMATION — Part 68

This equipment complies with Part 68 of the FCC rules and the requirements adopted by ACTA. On the exterior of this equipment is a label that contains a product identifier in the format US:AAAEQ##TXXXX. If requested, this information must be provided to your telephone company.

A plug and jack used to connect this equipment to the premises wiring and telephone network must comply with the applicable FCC Part 68 rules and requirements adopted by ACTA. A compliant telephone cord and modular plug is provided with this product. It is designed to be connected to a compatible jack that is also compliant. See installation instructions for details.

The REN is useful to determine the quantity of devices you may connect to your telephone line. Excessive RENs on a telephone line may result in the devices not ringing in response to an incoming call. In most, but not all areas, the sum of the RENs should not exceed five (5.0). To be certain of the number of devices you may connect to your line, as determined by the REN, contact your local telephone company. For product approved after July 23, 2001, the REN for this product is part of the product identifier that has the format US:AAAEQ##TXXXX. The digits represented by ### are the REN without the decimal point. (For example, 03 represents a REN of 0.3.) For earlier producers, the REN is separately shown on the label.

If this telephone equipment causes harm to the telephone network, the telephone company will notify you in advance that temporary discontinuance of service may be required. But if advance notice isn't practical, the telephone company will notify the customer as soon as possible. Also, you will be advised of your right to file a complaint with the FCC if you believe it is necessary.

The telephone company may make changes in its facilities, equipment, operations, or procedures that could affect the proper functioning of your equipment. If they do, you will be notified in advance in order for you to make necessary modifications to maintain uninterrupted service.

If trouble is experienced with this unit, for repair or warranty information, please contact customer service at (800) 544-4660. If the equipment is causing harm to the network, the telephone company may request that you disconnect the equipment until the problem is resolved.

DO NOT DISASSEMBLE THIS EQUIPMENT: it does not contain any user serviceable components.

We recommend the installation of an AC surge arrester in the AC outlet to which this equipment is connected. Telephone companies report that electrical surges, typically lightning transients, are very destructive to customer terminal equipment connected to AC power sources.

Exposure to RF Radiation

The internal wireless radio operates within the guidelines found in radio frequency safety standards and recommendations, which reflect the consensus of the scientific community. Independent studies have shown that the internal wireless radio is safe for use by consumers. Visit www.plantronics.com for more information.

NOTE: Modifications not expressly approved by Plantronics, Inc. could void the user's authority to operate the equipment.