

REVISION				
REV	DESCRIPTION	DATE	BY	CHK'D BY
J	CHANGE TO NEW BORDER.	28-MAR-12	JB	ES
K	REVISE DWG CALLOUTS, BOM ITEM 8	29-MAR-18	ES	AM
L	IMPEDANCE WAS 30 OHM, IS 75 OHM	23-APR-18	ES	AM
M	CHANGE MODEL FROM SHR TO SDR	18-DEC-18	ES	AM

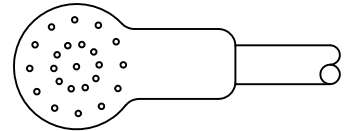

DYNAMIC MICROPHONE

DETAIL B
SCALE: 2=1

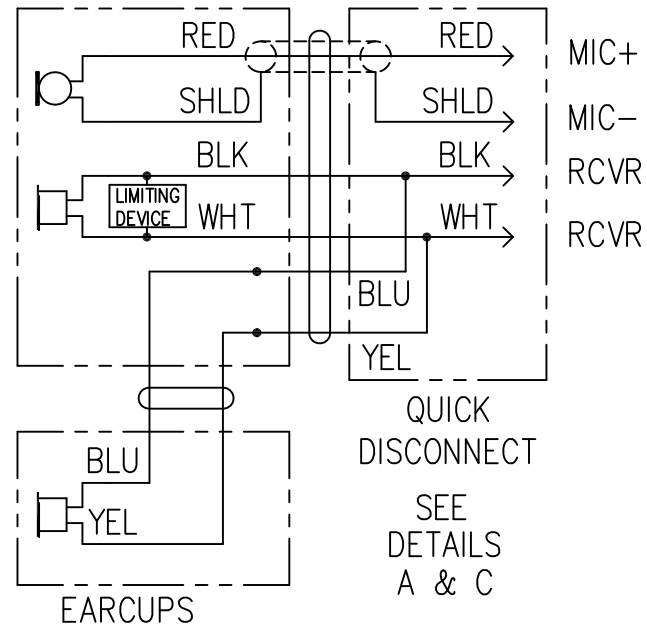
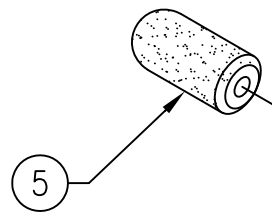

-02
SEE
DETAIL
C

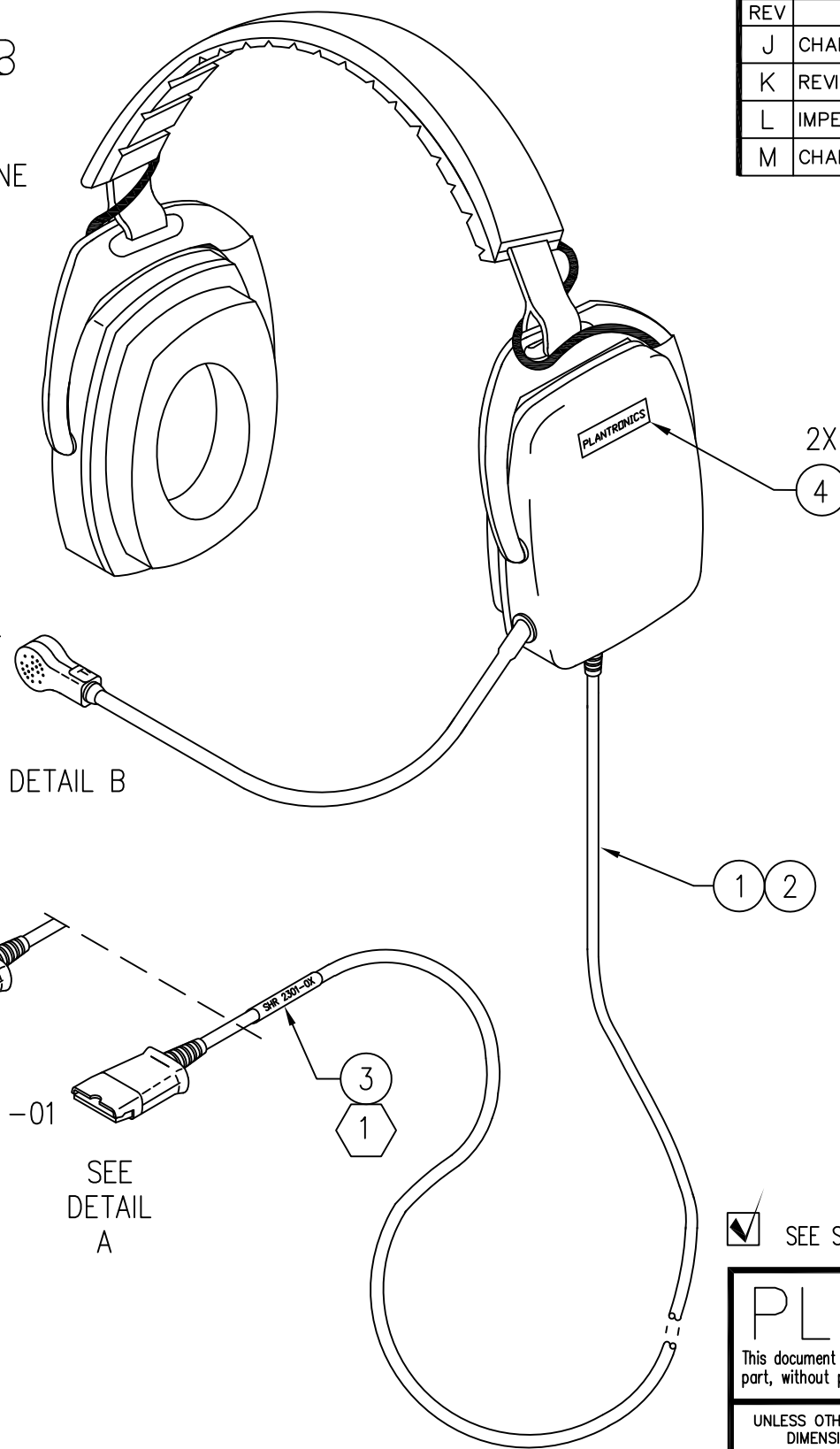

FEATURES

MICROPHONE TYPE	DYNAMIC.
IMPEDANCE	150 OHM, NOMINAL.
RECEIVER CONFIGURATION	BINAURAL.
IMPEDANCE	75 OHM, NOMINAL.
CABLES	30-INCH STRAIGHT, WITH QUICK-DISCONNECT OPTIONS.
COLOR	BLACK.
WARRANTY	ONE YEAR.

TABLE OF OPTIONS	
MODEL NO.	QDISC STYLE
SDR 2301-01	H-SERIES
SDR 2301-02	SUPRA

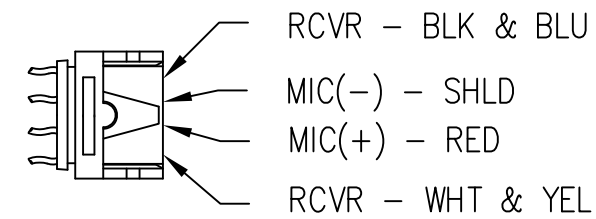

DETAIL A
-01

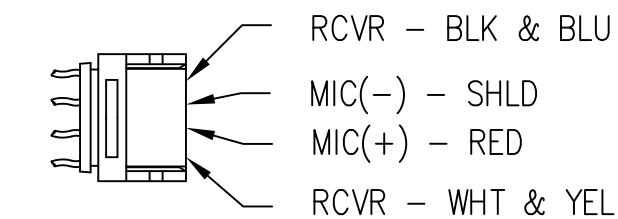

DETAIL C
-02

SEE SEPARATE BILL OF MATERIALS MATING PART. SEE NOTE

2. THIS IS A BINAURAL CIRCUMAURAL HEADSET WITH A DYNAMIC MICROPHONE AND QUICK-DISCONNECT OPTIONS.

1 IMPRINT THE MODEL NUMBER AND DATE CODE ON THE LABEL (ITEM 3). WRAP THE LABEL AROUND THE CABLE IN THE APPROXIMATE LOCATION SHOWN.

NOTES: (UNLESS OTHERWISE SPECIFIED)

THIRD ANGLE PROJECTION

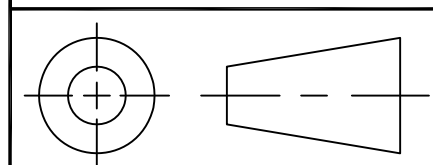

PLANTRONICS RESTRICTED

This document contains Plantronics, Inc. proprietary data, and is not to be copied, reproduced, used or divulged to unauthorized persons, in whole or in part, without proper authorization in writing from Plantronics, Inc. which reserves all rights to it.

UNLESS OTHERWISE SPECIFIED DIMENSIONS ARE IN: INCHES AND TOLERANCES ARE: DECIMAL .XX = ± .01 .XXX = ± .005 ANGLE = ± 2° FRACTION = ± 1/16	DO NOT SCALE		
	DRAWN BY J. BAKER	07/07/03	
MATERIAL:	CHECKED BY M. ERBE	07/07/03	SDR 2301-01,02
FINISH:	DEV ENG APPD RMS	07/30/03	SIZE B
	MFG APPD		CAT CODE 01
	PROD ENG APPD		DWG NO. 92301-0X
			REV. M
			SCALE NONE
			SHEET 1 OF 1